

Model No.: SDS-P830855
Product Line: Peerless

Rev: 1
Last Update: 2017-04-25 14:32:09

Product Description

The SDS compact woofer family offers low resonant frequency performance, ideally suited for compact sealed enclosures. This 4 inch 8 ohm member of the SDS family offer a coated paper cone with rubber surround, a high power voice coil suspended in a ferrite magnet motor, and a narrow-profile steel basket shaped to fit into narrow cabinets.



Mechanical Drawing

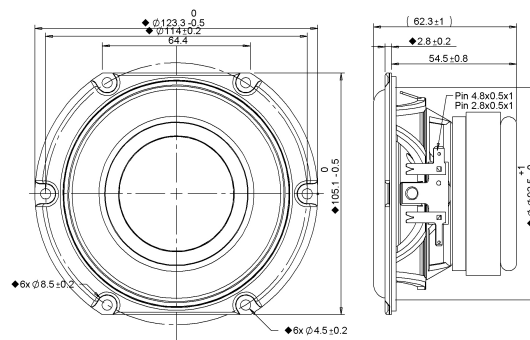

Specifications

DC Resistance	Revc	Ohms	5.6	5.0%	Energy Bandwidth Product	EBP	(1/Qes)*fs
Minimum Impedance	Zmin	Ohms	6.43	7.5%	Moving Mass	Mms	g
Voice Coil Inductance	Le	mH	0.24		Suspension Compliance	Cms	um/N
Resonant Frequency	Fs	Hz	63.26	15%	Effective Cone diameter	D	cm
Mechanical Q Factor	Qms		4.66		Effective Piston Area	Sd	cm ²
Electrical Q Factor	Qes		0.49		Effective Volume	Vas	L
Total Q Factor	Qts		0.44		Motor Force Factor	BL	Tm
Ratio Fs/Qts	F	Fs/Qts	143.78		Motor Efficiency Factor	β	(T*M ²)/Ohms
Half Space Sensitivity @2.83V	db@2.83V/1M	dB	84.78	+/- 1.0db	Voice coil former Material	VCfm	GSV
Half Space Sensitivity @1W/1M	db@1W/1M	dB	83.8	+/- 1.0db	Voice coil inner diameter	VCd	mm
Gap Height	Gh	mm	6		Rated Noise Power	P	W
Maximum Linear Excursion	Xmax	mm	3		Test Spectrum Bandwidth		60Hz-5KHz
Ferrofluid Type	FF				Driver Size	Inch	4 in
Driver Mass	Kg		0.74				

Frequency and Impedance Response

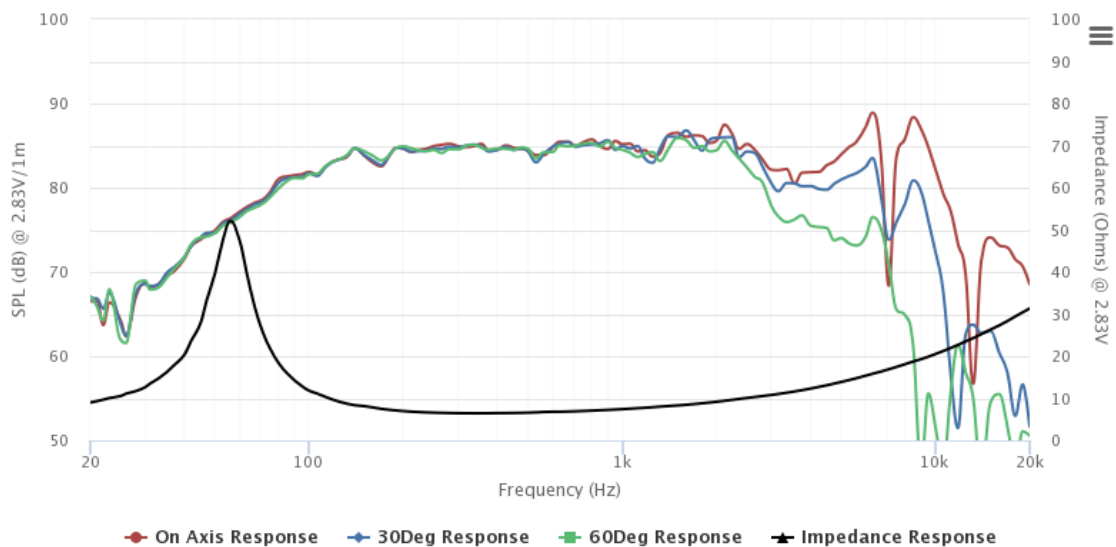

Highcharts.com